

# JVC®

# **COLOR TELEVISION AV-32920 USER'S GUIDE**





*Illustration of AV-32920 and RM-C754*

### **IMPORTANT NOTE TO THE CUSTOMER:**

In the space below, enter the serial number for your television.  
(The serial number is located on the rear of the television cabinet).  
Staple your sales receipt or invoice to the inside cover of this guide.  
Keep this user's guide in a convenient place for future reference.  
Keep the carton and original packaging for future use.

---

# IMPORTANT SAFETY PRECAUTIONS

**CAUTION**  
**RISK OF ELECTRIC SHOCK**  
**DO NOT OPEN**

**CAUTION: To reduce the risk of electric shock,  
do not remove cover (or back).  
No user serviceable parts inside.  
Refer servicing to qualified service personnel.**

 The lightning flash with arrowhead symbol, within an equilateral triangle is intended to alert the user to the presence of uninsulated "dangerous voltage" within the product's enclosure that may be of sufficient magnitude to constitute a risk of electric shock to persons.

 The exclamation point within an equilateral triangle is intended to alert the user to the presence of important operating and maintenance (servicing) instructions in the literature accompanying the appliance.

**WARNING:** TO PREVENT FIRE OR SHOCK HAZARDS, DO NOT EXPOSE THIS TV SET TO RAIN OR MOISTURE.

**CAUTION:** TO INSURE PERSONAL SAFETY, OBSERVE THE FOLLOWING RULES REGARDING THE USE OF THIS UNIT.

1. Operate only from the power source specified on the unit.
2. Avoid damaging the AC plug and power cord.
3. Avoid Improper installation and never position the unit where good ventilation is unattainable.
4. Do not allow objects or liquid into the cabinet openings.
5. In the event of trouble, unplug the unit and call a service technician. Do not attempt to repair it yourself or remove the rear cover.

Changes or modifications not approved by JVC could void the warranty.

\* When you don't use this TV set for a long period of time, be sure to disconnect both the power plug from the AC outlet and antenna for your safety.

\* To prevent electric shock do not use this polarized plug with an extension cord, receptacle or other outlet unless the blades can be fully inserted to prevent blade exposure.

## IMPORTANT SAFEGUARDS

### CAUTION:

**Please read and retain for your safety.**

Electrical energy can perform many useful functions. This TV set has been engineered and manufactured to assure your personal safety. But *improper use can result in potential electrical shock or fire hazards*. In order not to defeat the safeguards incorporated in this TV set, observe the following basic rules for its installation, use and servicing.

And also follow all warnings and instructions marked on your TV set.

### INSTALLATION

- 1 Your TV set is equipped with a polarized AC line plug (one blade of the plug is wider than the other).

(POLARIZED-TYPE)

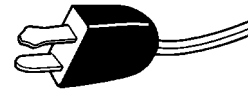

This safety feature allows the plug to fit into the power outlet only one way. Should you be unable to insert the plug fully into the outlet, try reversing the plug. Should it still fail to fit, contact your electrician.

- 2 Operate the TV set only from a power source as indicated on the TV set or refer to the operating instructions for this information. If you are not sure of the type of power supply to your home, consult your TV set dealer or local power company. For battery operation, refer to the operating instructions.
- 3 Overloaded AC outlets and extension cords are dangerous, and so are frayed power cords and broken plugs. They may result in a shock or fire hazard. Call your service technician for replacement.
- 4 Do not allow anything to rest on or roll over the power cord, and do not place the TV set where power cord is subject to traffic or abuse. This may result in a shock or fire hazard.
- 5 Do not use this TV set near water — for example, near a bathtub, washbowl, kitchen sink, or laundry tub, in a wet basement, or near swimming pool, etc.

- 6** If an outside antenna is connected to the TV set, be sure the antenna system is grounded so as to provide some protection against voltage surges and built-up static charges. Section 810 of the National Electrical Code provides information with respect to proper grounding of the mast and supporting structure, grounding of the lead-in wire to an antenna discharge unit, size of grounding conductors, location of antenna discharge unit, connection requirements for the grounding electrode.
- 7** An outside antenna system should not be located in the vicinity of overhead power lines or other electric light or power circuits, or where it can fall into such power lines or circuits. When installing an outside antenna system, extreme care should be taken to keep from touching such power lines or circuits as contact with them might be fatal.

**EXAMPLE OF ANTENNA GROUNDING AS PER NATIONAL ELECTRICAL CODE**

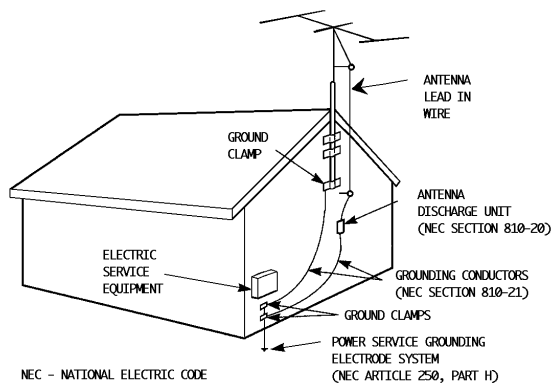

- 8** TV sets are provided with ventilation openings in the cabinet to allow heat generated during operation to be released. Therefore:
- Never block the bottom ventilation slots of a portable TV set by placing it on a bed, sofa, rug, etc.
  - Never place a TV set in a "built-in" enclosure unless proper ventilation is provided.
  - Never cover the openings with a cloth or other material.
  - Never place the TV set near or over a radiator or heat register.
- 9** To avoid personal injury:
- Do not place a TV set on a sloping shelf unless properly secured.
  - Use only a cart or stand recommended by the TV set manufacturer.
  - Do not try to roll a cart with small casters across thresholds or deep pile carpets.
  - Wall or shelf mounting should follow the manufacturer's instructions, and should use a mounting kit approved by the manufacturer.

**USE**

- 10** Caution children about dropping or pushing objects into the TV set through cabinet openings. Some internal parts carry hazardous voltages and contact can result in a fire or electrical shock.
- 11** Unplug the TV set from the wall outlet before cleaning. Do not use liquid or an aerosol cleaner.
- 12** Never add accessories to a TV set that has not been designed for this purpose. Such additions may result in a hazard.

- 13** For added protection of the TV set during a lightning storm or when the TV set is to be left unattended for an extended period of time, unplug it from the wall outlet and disconnect the antenna. This will prevent damage to product due to lightning storms or power line surges.
- 14** A TV set and cart combination should be moved with care. Quick stops, excessive force, and uneven surfaces may cause the TV set and cart combination to overturn.



**SERVICE**

- 15** Unplug this TV set from the wall outlet and refer servicing to qualified service personnel under the following conditions:
- A. When the power cord or plug is damaged or frayed.
  - B. If liquid has been spilled into the TV set.
  - C. If the TV set has been exposed to rain or water.
  - D. If the TV set does not operate normally by following the operating instructions. Adjust only those controls that are covered in the operating instructions as improper adjustment of other controls may result in damage and will often require extensive work by a qualified technician to restore the TV set to normal operation.
  - E. If the TV set has been dropped or damaged in any way.
  - F. When the TV set exhibits a distinct change in performance — this indicates a need for service.
- 16** Do not attempt to service this TV set yourself as opening or removing covers may expose you to dangerous voltage or other hazards. Refer all servicing to qualified service personnel.
- 17** When replacement parts are required, have the service technician verify in writing that the replacement parts he uses have the same safety characteristics as the original parts. Use of manufacturer's specified replacement parts can prevent fire, shock, or other hazards.
- 18** Upon completion of any service or repairs to this TV set, please ask the service technician to perform the safety check described in the manufacturer's service literature.
- 19** When a TV set reaches the end of its useful life, improper disposal could result in a picture tube implosion. Ask a qualified service technician to dispose of the TV set.
- 20** Note to CATV system installer. This reminder is provided to call the CATV system installer's attention to Article 820-40 of the NEC that provides guidelines for proper grounding and, in particular, specifies that the cable ground shall be connected to the grounding system of the building, as close to the point of cable entry as practical.

## WELCOME!

Congratulations on your new television purchase! We thank you for choosing JVC.

We know you are anxious to start watching your new television, but before you operate it, please read this guide and then keep it handy for future reference. After all, you just bought a great TV with a lot of terrific features, you should know what each feature is and how to use it properly!

Please note that the illustrations, diagrams, and menu pictures are not exact replicas of the actual television features. They are for reference only.

Again, congratulations and thank you for choosing JVC! Enjoy!

## TABLE OF CONTENTS

---

### CONNECTIONS

Connections Checklist . . . . .	5
Front & Rear Panel Diagrams . . . . .	5
Cable & VCR Connections . . . . .	6
Connecting to a Camcorder . . . . .	7
Connecting S-VHS Accessories (VCR or Camcorder) . . . . .	8
Connecting to an External Amplifier . . . . .	8
Connecting to JVC AV Compu Link Capable Components . . . . .	9

### GETTING STARTED

Remote Control . . . . .	10
Power . . . . .	11
Adjusting Volume . . . . .	11
Changing Channels . . . . .	11
Remote Programming . . . . .	12
CATV & Satellite Codes . . . . .	12
VCR Codes . . . . .	13

### MENU FUNCTIONS

Using the Menu . . . . .	14
Plug In Menu . . . . .	15
<i>Language</i>	
<i>Auto Tuner Setup</i>	
<i>Set Clock</i> . . . . .	16
<i>Finish</i>	
Picture Adjust . . . . .	17
<i>Tint</i>	
<i>Color</i>	
<i>Picture</i>	
<i>Bright</i>	
<i>Detail</i>	
<i>Notch</i>	
<i>Noise Muting</i>	
<i>Set Video Status</i>	

Sound Adjust . . . . .	18
<i>Bass</i>	
<i>Treble</i>	
<i>Balance</i>	
<i>MTS (Multi-channel Stereo Sound)</i>	
<i>Some Sound Advice</i>	
Clock/Timers . . . . .	19
<i>On/Off Timer</i>	
<i>Set Lock Code</i>	
Initial Setup . . . . .	20
<i>TV Speaker</i>	
<i>Audio Out</i>	
<i>Closed Caption</i>	
<i>Channel Summary</i> . . . . .	21

### BUTTON FUNCTIONS

Display . . . . .	22
Closed Caption . . . . .	22
Video Status . . . . .	22
Sleep Timer . . . . .	22
Hyper Surround . . . . .	23
TV/Video . . . . .	23
100+ . . . . .	23
VCR . . . . .	23
Menu Buttons . . . . .	23
Muting . . . . .	23
Return+ . . . . .	23
Number Buttons (10 Key Pad) . . . . .	23

### APPENDICES

Troubleshooting . . . . .	24
Limited Warranty . . . . .	25
Authorized Service Centers . . . . .	26
Specifications . . . . .	27

## CONNECTIONS CHECKLIST Ñ READ ME FIRST!

The Connections Checklist — Read Me First! section of this guide is a list of ideas to keep in mind when you set out to perform your connections. It is designed to help us not-so-technically-advanced individuals. If you read this section, and can't identify the plugs, connectors, and components you have, do not be afraid to seek help.

**1) Always refer to the connection instructions** in the user's guide for your components first! The manufacturer will provide the most detailed information about their products.

**2) Know your jacks and plugs** — most are color coded:

- Yellow plugs are Video connections
- Red plugs are Right Audio connections
- White or black plugs are Left Audio (Mono) connections (if your VCR is mono, it will have a white or black plug, no red)

**3) Perform one hookup at a time.** If you have many accessories to connect, make sure each connection is correct by checking to see that it works properly before attempting the next connection.

**4) Unplug the power cord** between each connection.

**5) In and Out Concept.** Remember In and Out. The Output jack from one piece will go to the Input jack of the other — read the jack panels, they are all labeled.

A/V input plug



RF Connectors



S-Video Plug

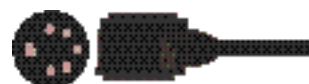

## FRONT & REAR PANEL DIAGRAMS

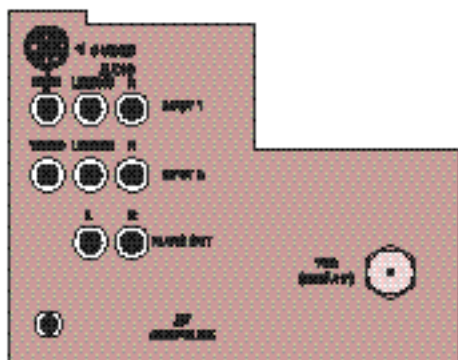

REAR PANEL DIAGRAM

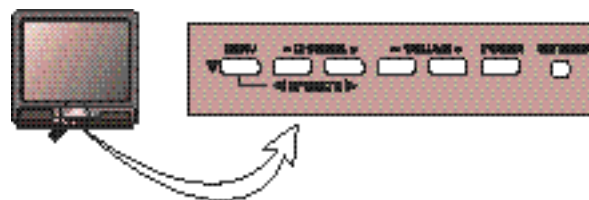

FRONT PANEL DIAGRAM



# 6 CONNECTIONS

## CABLE & VCR CONNECTIONS

There are two basic types of antenna or cable hookups. If you have an antenna, or have a cable TV system that does not require you to use a cable box to tune channels, use **Diagram #1**. If you have a cable system that requires you to use a cable box to access all channels, use **Diagram #2**. If you have a cable system that requires you to use a cable box to access certain premium channels, but not regular basic channels, use **Diagram #3**.

**NOTE:** To get stereo sound from a hi-fi stereo VCR, you must connect it to the TV with Audio/Video cables. Also, to get the best picture quality from any VCR use Audio/Video cables. (Use them! You'll be glad you did.)

#1

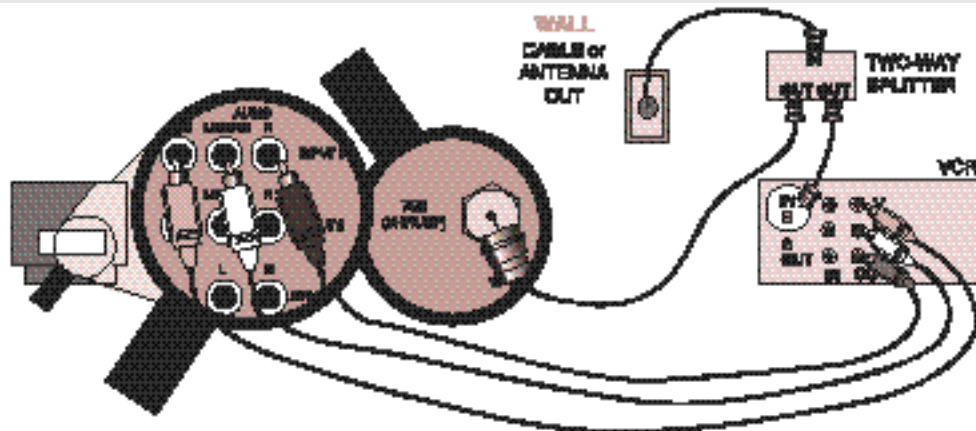

- 1) Connect cable or antenna RF wire *out* from the wall, *in* to the splitter RF input.
  - 2) Connect RF wire *Out* from the splitter RF output, *in* to the VCR RF input.
  - 3) Connect RF wire *Out* from the splitter RF output, *in* to the TV VHF/UHF input.
  - 4) Connect yellow video cable *out* from the VCR Video output, *in* to the TV Video input jack.
  - 5) Connect white audio cable *out* from the VCR Left Audio output, *in* to the TV Left Audio input jack.
  - 6) Connect red audio cable *out* from the VCR Right Audio output, *in* to the TV Right Audio input jack.
- If your VCR is mono it has only one audio out jack, connect it to TV L/Mono input.

#2

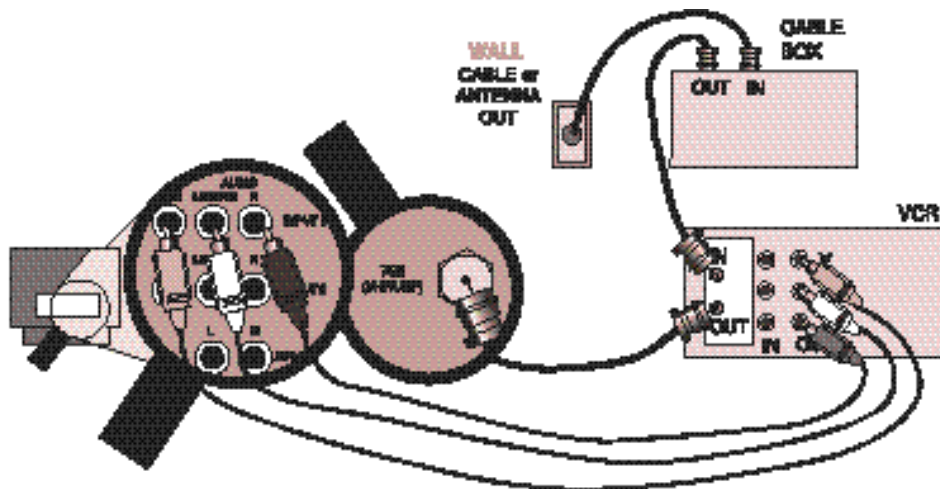

- 1) Connect the
  - 2) Connect RF
  - 3) Connect RF wire *Out* from the VCR RF output, *in* to the TV VHF/UHF input.
  - 4) Connect yellow video cable *out* from the VCR Video output, *in* to the TV Video input jack.
  - 5) Connect white audio cable *out* from the VCR Left audio output, *in* to the TV Left Audio input jack.
  - 6) Connect red audio cable *out* from the VCR Right Audio output, *in* to the TV Right Audio input jack.
- If your VCR is mono it has only one audio out jack, connect it to TV L/Mono input.

## CABLE & VCR CONNECTIONS CONTINUED

#3

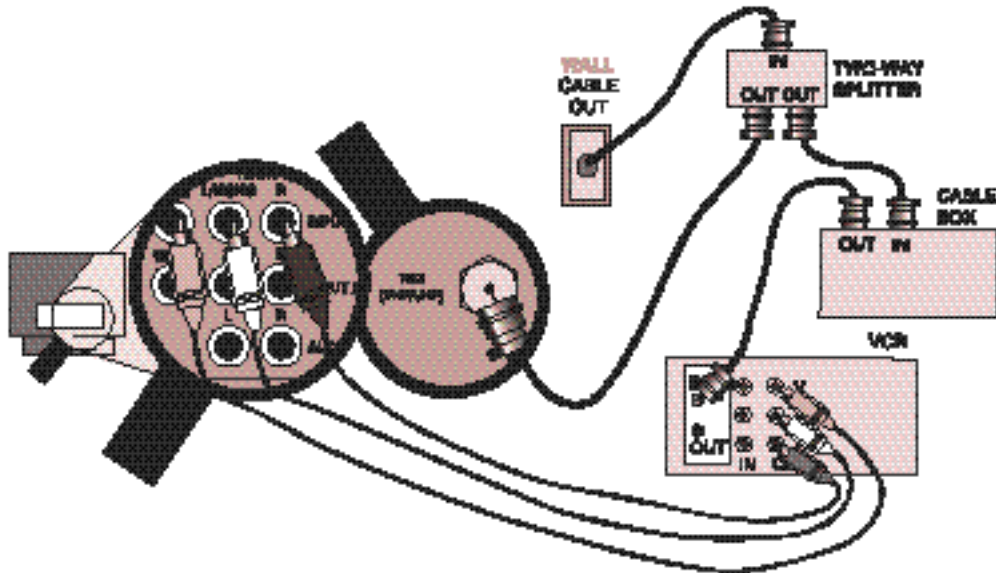

- 1) Connect Full Cable Out to the In of the Three-Way Splitter.
  - 2) Connect RF Out from splitter RF output, in to cable box RF input.
  - 3) Connect RF wire Out from cable box RF output, in to VCR RF input.
  - 4) Connect RF wire Out from splitter RF output, in to TV VHF/UHF input.
  - 5) Connect yellow video cable out from VCR Video output, in to TV Video input jack.
  - 6) Connect white audio cable out from VCR Left audio output, in to TV Left Audio input jack.
  - 7) Connect red audio cable out from VCR Right Audio output, in to TV Right Audio input jack.
- If your VCR is mono it has only one audio out jack, connect it to TV L/Mono input.

## CONNECTING TO A CAMCORDER

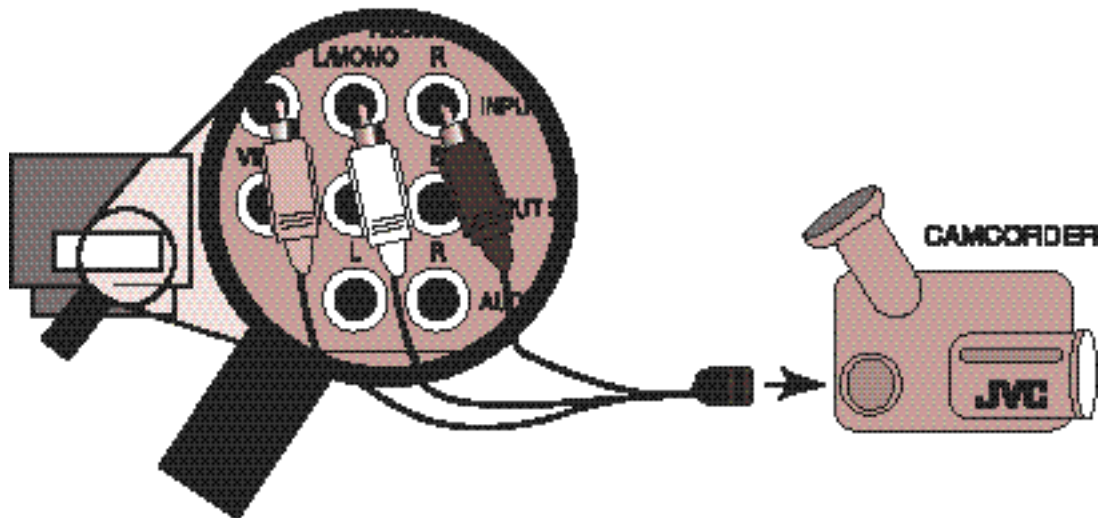

Connect a camcorder to your TV.

- 1) Connect white audio cable out from the camcorder plug, in to the TV Left Audio input jack.
  - 2) Connect yellow video cable out from the camcorder plug, in to the TV Video input jack.
  - 3) If you have a stereo model camcorder, connect red audio cable out from the camcorder, in to the TV Right Audio input jack.
- Refer to the camcorder's instruction book for any special instructions.



## 8 CONNECTIONS

### CONNECTING S-VHS ACCESSORIES (VCR or Camcorder)

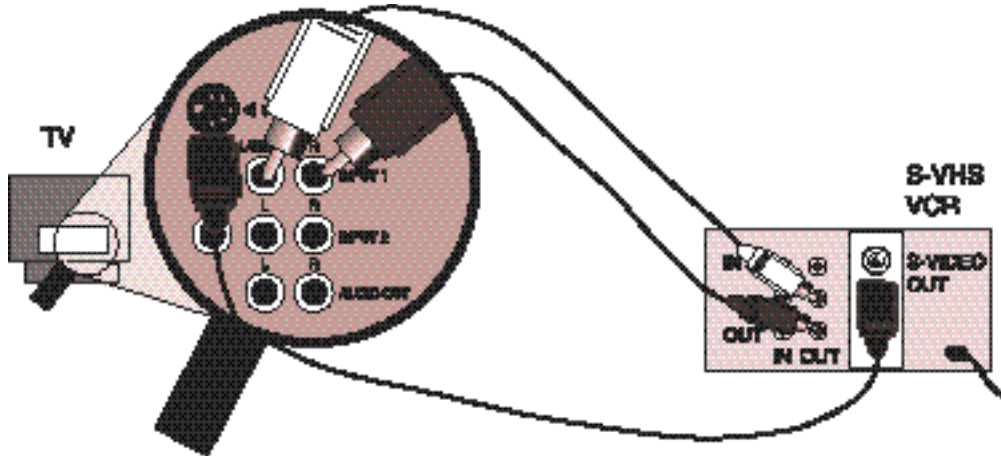

Keeping the audio connections the same as for a non-S-VHS VCR or camcorder (page 7), use the special S-VHS cable that came with the VCR or Camcorder. Illustration is of S-VHS VCR hookup.

1) Connect the S-VHS Plug *out* from VCR S-Video output, *in* to the TV's S-Video input.

☐ Refer to your VCR or camcorder instructions.

---

### CONNECTING TO AN EXTERNAL AMPLIFIER

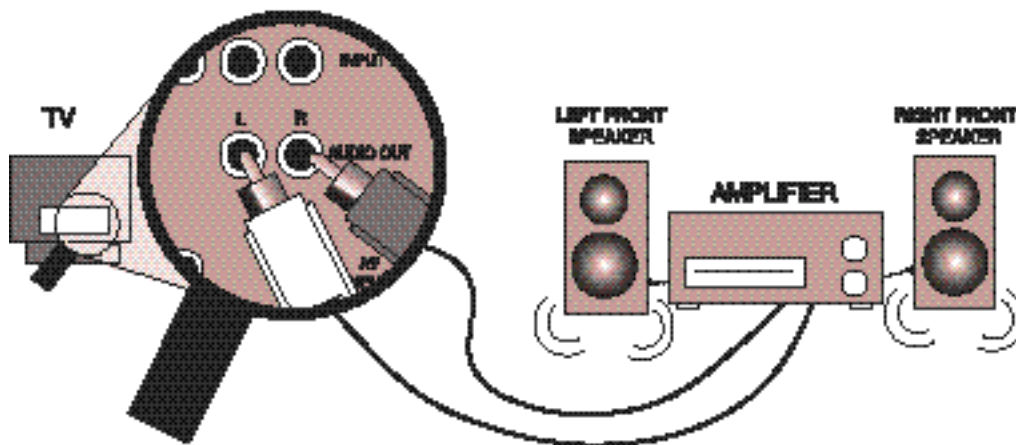

Set the TV Speaker to OFF (page 20), switch the audio output to VARI (page 20), and adjust the sound with the TV remote's VOLUME +/- button (page 11.)

1) Connect white audio cable *out* from the TV Left Audio output jack *in* to the Amplifier [Left] input.

2) Connect red audio cable *out* from the TV Right Audio output jack *in* to the Amplifier [Right] input.

☐ Refer to the amplifier's instructions.



## CONNECTING TO JVC AV COMPULINK CAPABLE COMPONENTS

AV Compu Link makes playing video tapes totally automatic. Simply insert a pre-recorded tape\* into the VCR, and the VCR automatically turns on and starts playing. At the same time, the VCR sends an AV Compu Link signal to the television telling it to turn on and switch to the correct video input.

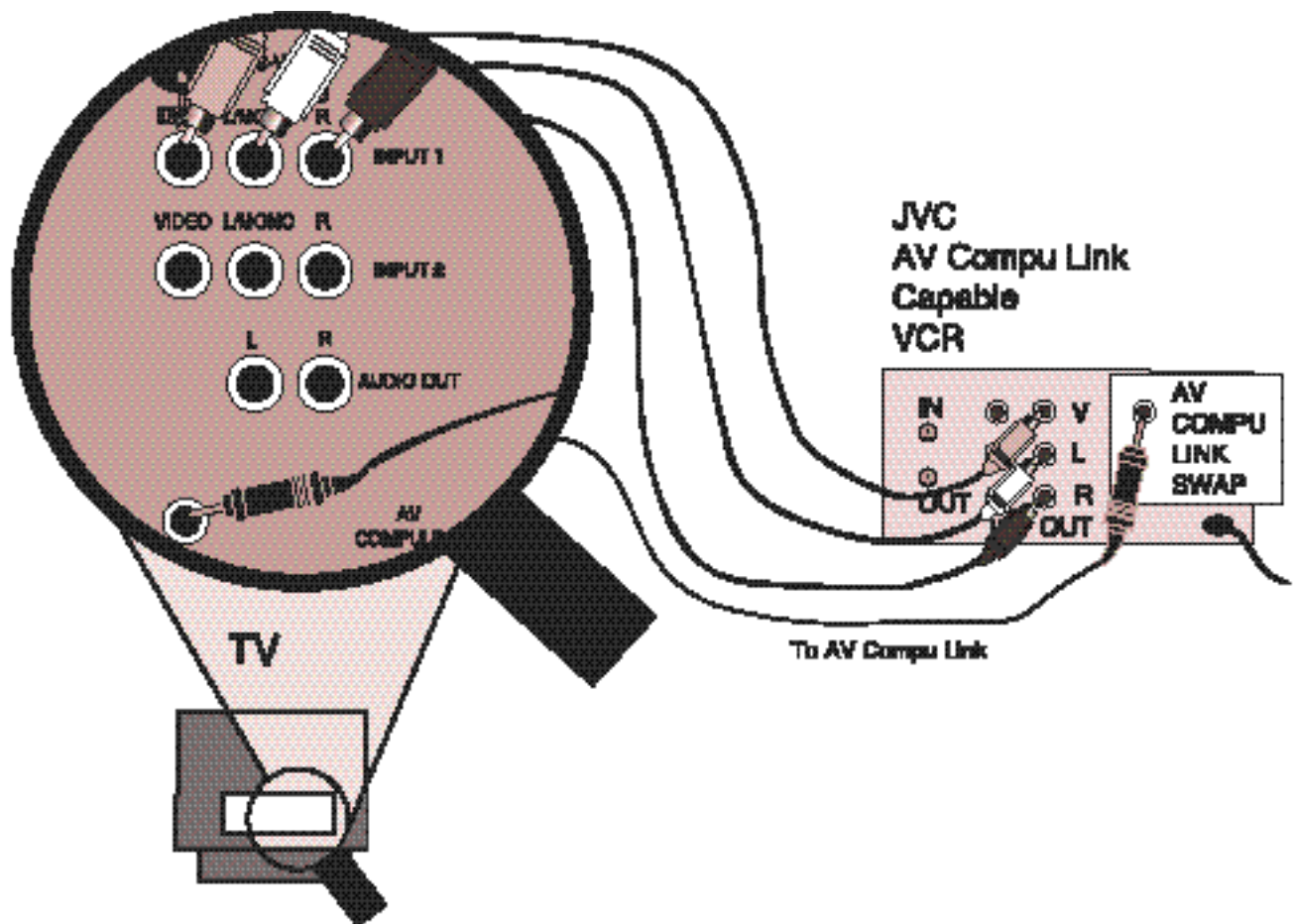

### NOTES:

- 1) The AV Compu Link cable has a Male 3.5 mm (mono) mini plug on each end.
- 2) If your JVC brand VCR has A Code/B Code Remote Control Switching (see VCR instructions), using VCR A Code will switch the TV to Video Input 1. Using B Code will switch the TV to Video Input 2.
- 3) To connect a JVC HiFi receiver or amplifier for a completely automated home theater, see the HiFi receiver's instructions for detailed hookup diagrams.

\* In order for AV Compu Link to work, the recording tabs must be removed from the VHS tape.

\*\*AV COMPU LINK EX is compatible with the following 1998 receivers: RX-664, RX-774, RX-884, and RX-1024 and later receiver models.



# GETTING STARTED

## REMOTE CONTROL

RM-C754  
AV-32920



### CHANGING THE REMOTE CONTROL'S BATTERIES

1 Use only size AA batteries.

2 Push down on the remote's back cover and slide towards the bottom to remove it.

3 Insert the two supplied AA batteries, carefully noting the "+" and "-" markings on the batteries and remote control.

To avoid a short circuit, insert "-" end first. Slide the cover back into place (until it clicks into position).

- If it takes more than three minutes to change the batteries, you may have to reprogram the CATV and/or VCR codes (see page 12-13.)
- If the remote control acts erratically, replace the batteries. Battery life is usually six months to one year.
- We recommend the use of alkaline batteries for longer battery life.

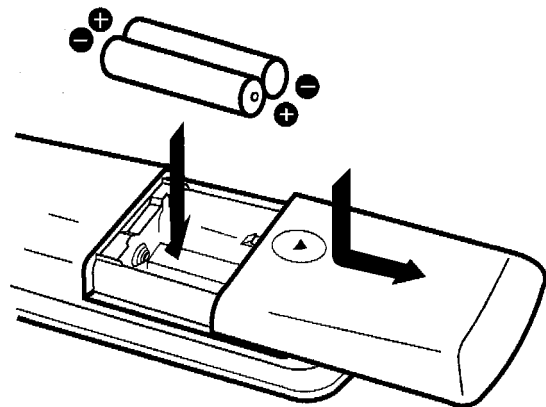

## POWER

- Make sure that the TV/CATV switch is set to TV. Switch to CATV only if you plan to operate a cable box.
- Press the POWER button on the remote control or the TV front panel. The On Timer lamp will glow red.
- The first time you turn on the TV, the "Plug In Menu" will appear. You should turn to page 15 now to learn more about this menu.
- To turn the power off, press the POWER button again. The On Timer lamp will go out.
- The On Timer lamp remains on while the On/Off Timer function is active.

## ADJUSTING VOLUME

- 1** Press the VOLUME button on the front panel or remote control. The volume sidebar will appear.



- 2** Press the MUTING button to instantly turn the volume off. To restore the volume to the previous level, press the MUTING button again.

## CHANGING CHANNELS

- 1** 10 key direct access.

Press the numbers on the remote's 10 key pad. For single-digit channel numbers press 0 then the number. For channels above 100, press the 100+ button plus the 2-digit number.

- 2** CHANNEL +/- button.

Press the CHANNEL +/- button, it will scan the channels in order.

- NOTE: After you operate the Auto Tuner Setup (page 15), all of the blank, or empty, channels will be removed from scanning so that there is no noise or channel snow when you scan, only active channels.*

- 3** Return.

Press and release the RETURN+ button to return to the previous channel. First, select a channel (game #1). Then, select another channel (game #2) with the 10 key pad and push the RETURN+ button to flip directly back and forth.

- 4** Return+ .

Press and hold down the RETURN+ button for three seconds. The message, "RETURN CHANNEL PROGRAMMED !" will appear and you can scan as you wish. Press RETURN+ again and you will go back to the Return+ channel.

To cancel a Return+ channel, press and hold down the RETURN+ button for another three seconds and the message, "RETURN CHANNEL CANCELLED !" appears.

- Pressing a number key or turning the set off will also cancel a Return+ channel.



# REMOTE PROGRAMMING

## SETTING THE CATV & VCR CODES

Many CATV & VCR brands have more than one code. If the first code in the list does not work, try the other codes listed. If your CATV box or your VCR do not respond to any of the codes listed for the manufacturer, use the remote control for that accessory to operate it.

### CABLE BOX OR SATELLITE SETUP

- 1) Determine the correct code from the "CATV & Satellite Codes" chart below.
- 2) Slide the 2-Way Mode Selector Switch to CATV.
- 3) Press and hold down the DISPLAY button.
- 4) Enter the 2-digit code with the 10 key pad while continuing to hold down the DISPLAY button.
- 5) Release the DISPLAY button.
- 6) Confirm the operation of the cable box.

### CATV & Satellite Codes

CABLE BOXES	CODES	CABLE BOXES	CODES	CABLE BOXES	CODES
ABC	35 01 11 02 33 91 55	Memorex	07	Starquest	04
Antronix	44	Movietime	32 39 29 42 44 88 40 38 60	Sylvania	19 35
Archer	29 01 44 88 91 63 42 30 52 76	NSC	38 40 32	Tandy	62
Belcor	82	Oak	11 46 10 12 47	Teknika	74 54
Cablestar	82	Panasonic	16 17	Telecaption	92 77
Cabletenna	29 01 44 88 91 76	Paragon	07	Televue	32 40 42 78 94
Cableview	63 44 42 30 52 88	Philips	13 20 23 24 96 30 84	Texscan	18 19 35
Century	63 44 42 30 52 88	Pioneer	05 06 78	Tocom	33 34 48 49 01 42 91 73
Citizen	63 44 42 30 52 88	Popular Mechanics	59	Toshiba	36 07 66 70
Colour Voice	23	Pulsar	63 44 42 30 52 88 07	Tusa	04
Comtronice	42 21	Quest	01 02 03 04 34 55 83 85 91 93	TV86	40
Contec	10		95	Uniden Satellite	65 69
Curtis	08 09 56 61 87 90	RCA	16 17	Unika	29 01 44 88 91 63 42 30 52
Diamond	29 01 44 88 91 76	Realistic	51 44 88 53		76
Drake	37 67 71	Recoton	59 63 44 42 30 52 88	United Artists	11
Eagle	13 22 58 62 20 40 26 21	Regal	14 41	United Cable	01
Eastern	28 99	Regency	28 99	Universal	42 43 44 52 63 88 82
Focus	59	Rembrandt	32 39 29 42 44 88 02 60	Videoway	07 50 23 45
GCElectronics	63 44 42 30 52 88 82	Runco	07	Vid Tech	64
Gemini	04 85 32 30	Salora	68 72	Vidter	64
General Electric	57	Samsung	16 17 06 32 40 42 78 94	Viewstar	13 22 58 62 20 40 26 21
General Instruments	01 02 03 04 34 55 83 85 91 93	Scientific Atlanta	08 09 56 61 87 90	Zenith	07 50 23 75
	95	Sheritech	27	Zentek	59
Gerrard	63 44 42 30 52 88	Signal	13 22 58 62 20 40 26 04 42 32		
Hamlin	14 15 28 41 99		42 78 94 21	<b>DIGITAL</b>	
Hitachi	31 79 02 80	Signature	02	<b>SATELLITE</b>	<b>CODES</b>
Hytex	11	SL Marx	32 40 42 78 94 63 44 30 52 88	<b>SYSTEMS</b>	
Jerrold	01 02 03 04 34 55 83 85 91 93	Sprucer	16 17		
	95	Standard Components	32 39 29 42 44 88 18 60	RCA	97
Macom	31 79 80	Starcom	01 04 55	Sony	98
Magnavox	25 26 13	Stargate	32 40 42 78 94 04 63 44 30 52		
Matsushita	16 17		88		

### VCR SETUP

The remote is pre-programmed with the VCR codes for power on and power off, play, stop, record, pause, fast-forward, rewind, and channel up and down.

- 1) Determine the correct code from the "VCR Codes" chart (page 13).
- 2) Slide the 2-Way Mode Selector Switch to TV.
- 3) Press and hold down the DISPLAY button.
- 4) Enter the 2-digit code with the 10 key pad while continuing to hold down the DISPLAY button.
- 5) Release the DISPLAY button.
- 6) Confirm the operation of the VCR.

When you record a channel, press the PLAY button while continuing to hold down the REC button.

## VCR Codes



VCRs	CODES	VCRs	CODES	VCRs	CODES
Admiral	84 40 07 31 06 65	Headquarter	16	Pulsar	34 35 46 47 18 24 03 94 52 15
Aiko	46	HI-Q	08		27 89 32 90 91 83
Aiwa	31 35 94 27 03 87 34 28 26 29	Hitachi	39 02 25 89 94 28 64 70 81	Quarter	16
Akai	32 33 20 26 28 64 21	Homeline	89 15 31 36 46 47 79 94	Quartz	16
American High	01 05	Images	90 91	Quasar	65 01 02 05 06 41 42 71 04 18
Asha	03	ITT	28 15 26 29 53 55 59		03 56 92 72
Astra	03 94 52 15 27 89 32 90 91 83	J.C. Penney	65 02 15 27 03 05 94	Radix	15
Audio Dynamics	26 27 88 97 64	Jensen	26 29 28 64	Radio Shack	31 15
Audiovox	15	JVC	00 85 28 15 26 29 64 53 55 59	Randex	89 15 31 36 46 47 79 94
Aventura	31 35 94 27 03 87 34 28 26 29	Kenwood	26 28 29 27 64 16	RCA	98 03 02 05 06 56 57 72 34 04
Beaumarck	98 03 02 05 06 56 57 72 34 04	KLH	35 43		99 70 75
	99 75	Kodak	01 05 15	Realistic	65 07 15 16 08 31 32 01 05 84
Belcor	34 35 46 47	Lloyd	31 35 94 27 03 87 34 28 26 29		40 09 03
Bell & Howell	16 08 76	Lloyd's	11	Ricoh	30
Broksonic	10 12 35 87 77 78	Logik	31 35 94 27 03 87 34 28 26 29	Runco	24
Calix	15	LXI	15	Sanky	18 24 07 84
Candle	03 94 52 15 27 89 32 90 91 83	Magnasonic	34 35 46 47 03 94 52 15 27 89	Sansui	43 31 26 28 64 29 03
Canon	65 01 02 05 06 41 42 71 04 18		32 90 91 83	Samsung	03 94 52 15 27 89 32 90 91 25
	03 56 92 22	Magnavox	65 18 05 25 31 01 24 06 56 35		83
Capehart	34 35 46 47		94 27 03 87 34 28 26 29	Sanyo	16 08 76 03
Carrera	03 94 52 15 27 89 32 90 91 83	Magnin	03 94 52 15 27 89 32 90 91 83	Scott	10 11 19 74 87 25 12 14
Carver	18 24	Marantz	27 21 01 05 18 24	Sears	02 15 16 09 08 61 34 19 65 31
CCE	35 46	Marta	89 15 31 36 46 47 79 94		67 01 05 39 51 73 70 00 85
Citizen	89 15 31 36 46 47 79 94	Matsui	03 94 52 15 27 89 32 90 91 26	Semitsu	34 35 46 47
Classic	89 15 31 36 46 47 79 94		31 16 29 83	Sharp	84 40 07 31 06 65
Colortyne	27 21 01	Matsushita	01 05	Shintom	35 43
Colt	35	Megasonic	02 15 16 09 08 61 34 19 65 31	Shogun	03 94 52 15 27 89 32 90 91 83
Craig	03 08 15 43 31 26 28		67	Signature	65 01 02 05 06 41 42 71 04 18
Crosley	31 35 94 27 03 87 34 28 26 29	MEI	01 05		03 56 92 84 40 07 31 06
Curtis	34 35 46 47 03 94 52 15 27 89	Memorex	65 15 08 31 07 16 01 05 18 84	Singer	35 43
	32 90 91 83		03 24	Sony	23 30 38 50 49 16 17 01 05 48
Curtis Mathes	65 01 02 05 06 41 42 71 04 18	MGA	19 92 20 21 67 80 95 45	Soundesign	31 35 94 27 03 87 34 28 26 29
	03 56 92	MGN	03 94 52 15 27 89 32 90 91 83	STS	02 39
Cyberex	03 94 52 15 27 89 32 90 91 83	MGN Technology	03	Sylvania	65 96 18 05 31 25 01 19 45
Daewoo	34 35 46 47 25	Midland	98 03 02 05 06 56 57 72 34 04	Symphonic	31 35 94 27 03 87 34 28 26 29
Daytron	34 35 46 47		99 75	Syqmax	34 35 46 47
DBX	26 27 88 97 64	Minolta	39 02 25 89 94 70	Talung	26 29 28 64
Denon	98 03 02 05 06 56 57 72 34 04	Mitsubishi	19 92 20 21 67 80 95 29 45	Teac	31 35 94 27 03 87 34 28 26 29
	99 75	Mont. Ward	65 01 02 05 06 41 42 71 04 18		64
Dumont	03 94 52 15 27 89 32 90 91 83		03 56 92 84 40 07 31 06	Technics	65 01 02 05 06 41 42 71 04 18
Dynatech	31 35 94 27 03 87 34 28 26 29	Motorola	01 05 07 84		03 56 92
Dynatone	89 15 31 36 46 47 79 94	MTC	31 35 94 27 03 87 34 28 26 29	Technivox	89 15 31 36 46 47 79 94
Electrohome	19 92 20 21 67 80 95 15 45		52 15 89 32 90 91 83	Teknika	31 36 65 01 15 05
Electron	98 03 02 05 06 56 57 72 34 04	Multitech	31 35 94 27 03 87 34 28 26 29	Telefunken	11 31
	99 75	NAD	54	Thomas	31 35 94 27 03 87 34 28 26 29
Electroponic	28 15 26 29 53 55 59	National	98 03 02 05 06 56 57 72 34 04	TMK	11 31 03
Emerex	38		99 75	Toshiba	02 25 73 19 45 09
Emerson	10 87 11 12 13 14 08 15 86 37	NEC	26 27 88 97 28 64 29	Totevision	03 94 52 15 27 89 32 90 91 83
	62 19 25 65 58 78 77 31 45 20	Nikko	89 15 31 36 46 47 79 94	Unitech	03 94 52 15 27 89 32 90 91 83
	21 60 66	Noblex	03	Vector	25
Encore	65 01 02 05 06 41 42 71 04 18	Olympus	65 01 02 05 06 41 42 71 04 18	Vector Research	27 21 01
	03 56 92		03 56 92	Video Concepts	27 21 01 25 20
Everex	39 02 25 89 94 70	Optimus	54 15 07 84	Videosonic	26 27 31 16 29 03
Fisher	08 09 51 16	Optonica	84 40 07 31 06 65	Wards	31 01 05 02 08 07 84 40 35 06
Fuji	01 05 23	Panasonic	65 01 02 05 06 41 42 71 04 18		56 25 03
Funai	31 35 94 27 03 87 34 28 26 29		03 56 92 72 82	XR-1000	31 35 94 27 03 87 34 28 26 29
Garrard	31	Paxsonic	03 94 52 15 27 89 32 90 91 83		01 05
GE	65 03 04 05 06 56 01 57	Penney	01 05 15 27 02 39 51 03	Yamaha	26 27 31 16 29 28 64
Goldstar	89 15 31 36 46 47 79 94 27	Pentax	65 02 39 70	Zenith	93 23 24 30 18
Go Video	90 91	Philco	65 01 02 05 06 41 42 71 04 18		
Gradiente	31		03 56 92 34 35 46 47		
Granada	65 01 02 05 06 41 42 71 04 18	Philips	65 96 18 05 31 25 01 40		
	03 56 92	Pilot	89 15 31 36 46 47 79 94		
Grundig	01	Pioneer	39 02 25 89 94 54 44 29 70		
Harley Davidson	31 35 94 27 03 87 34 28 26 29	Portland	34 35 46 47		
Harmon/Kardon	21 19 27 20	Proscan	98 03 02 05 06 56 57 72 34 04		
Harvard	35 43		99 75		
Harwood	35	Protec	35		



# USING THE MENU

## USING THIS GUIDE:

Throughout this guide there are certain symbols we use as shorthand to show you what to do. When you see them, keep these factors in mind:

- ▲▼ Up and down arrows indicate you should press the MENU UP or MENU DOWN button. This function allows you to:
  - Move vertically in the main menu
  - Move through a submenu, or
  - Move to the next letter, number, or other choice in a submenu
  - Back up to correct an error
- ◀▶ Left and right arrows indicate you should press the MENU LEFT or MENU RIGHT button to:
  - Select the highlighted item, or
  - Select the options in a submenu
-  The "Press Button" icon means you should press that button on the remote control.
-  The "Helping Hand" icon points to the highlighted or selected item in a menu.

**To use the Menu,** press any of the remote's 4-way cursor control (MENU) buttons and JVC's transparent scrolling menu will appear on screen. The item that appears yellow is the selected item.

*NOTE: The menu screens depicted in this book are representations of the menu screens on your set. They are not exact replications.*

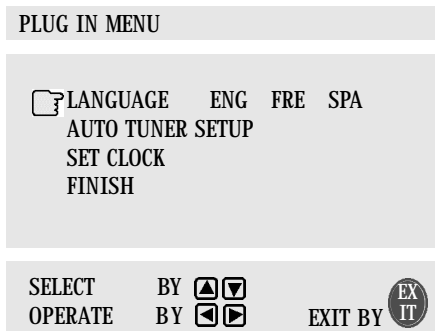

The "Plug In Menu" only appears immediately after the TV is plugged in, or after a power interruption of more than 90 seconds.

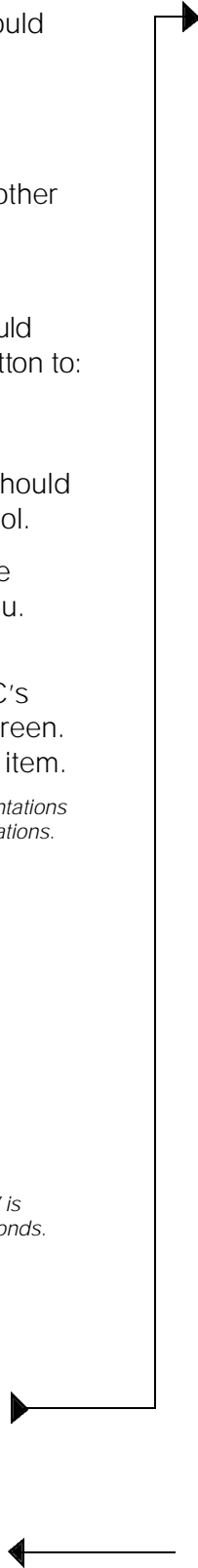
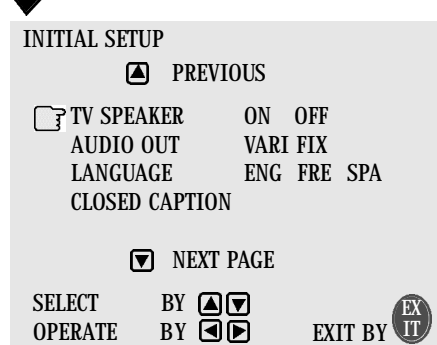
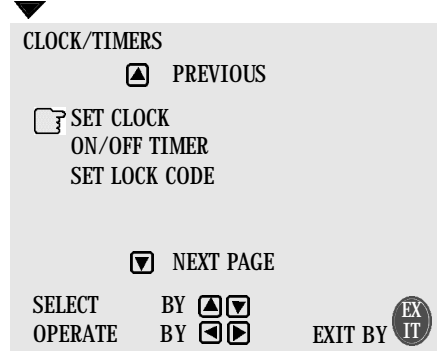
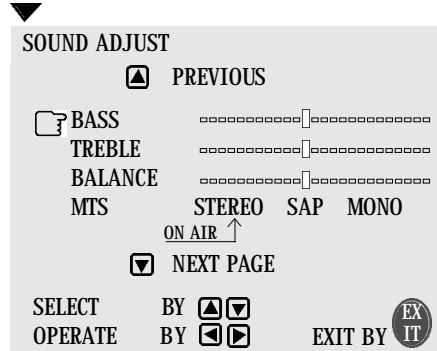
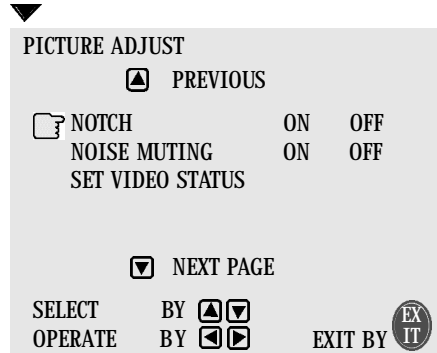
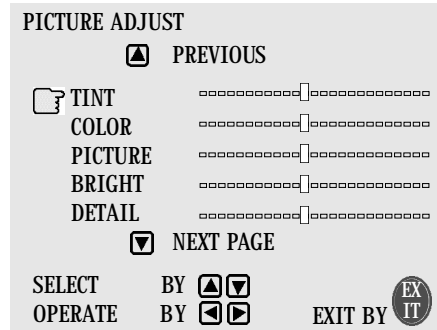
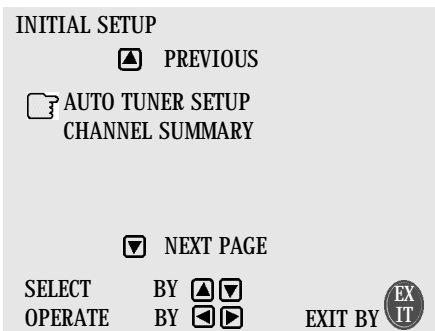





## PLUG IN MENU

The Plug In Menu comes up automatically when you first turn on the TV after plugging it in. The Plug In Menu sets the default preferences for you for:

- The Language in which you want the onscreen displays to appear.
- The Auto Tuner Setup of channels to be included in scan.
- The Tuner Mode the TV is set to — Air or Cable.
- The time of the TV's Clock.

Once you have set your preferences in the Plug In Menu section, it will not appear again unless there is a power interruption.

## LANGUAGE

Your JVC television allows you to choose from English, French, or Spanish on-screen menus and displays.

▲▼ To LANGUAGE

LANGUAGE    ENG    FRE    SPA

◀▶ To choose the language

→ ENGLISH ↔ FRENCH ↔ SPANISH →

## AUTO TUNER SETUP

During Auto Tuner Setup, the TV will automatically scan through all available channels and memorize the active ones so that when you scan, you do not pick up weak or noisy channels.

▲▼ To AUTO TUNER SETUP

◀▶ To operate

TUNER MODE    CABLE    AIR  
START

◀▶ To choose CABLE or AIR

▲▼ To move to START

◀▶ To start Auto Tuner Setup

NOW  
PROGRAMMING!

▶▶▶ ◻ ▶▶▶  
48

The Programming takes approximately  
1 to 2 minutes

PROGRAMMING OVER!

**Note:** You should perform the Auto Tuner Setup for both Cable and Air, if you have cable or a satellite system.

**Note:** Noise Muting will not work while Auto Tuner Setup is working.

### NOTES:

You can exit the Plug In Menu at any time by pressing the EXIT button on the remote control. You can enter the Plug In Menu any time by simultaneously pressing the MENU button and VOLUME "—" button on the TV's front panel.



# PLUG IN MENU

## NOTES:

Remember, the Plug In Menu will only appear after you turn on the TV for the first time, or after a power interruption.

## SET CLOCK

The Clock is the heart of all timer functions. You must set the clock before the On/Off Timer will work.

- ▲▼ To SET CLOCK
- ◀▶ To operate



- ◀▶ To set the hour (AM/PM)
- ▼ To move to minutes
- ◀▶ To set the minutes
- ▼ To move to START CLOCK when done with settings
- ◀▶ To start the clock



If you want to synchronize the TV clock with another clock or time signal, press LEFT or RIGHT MENU arrow at the appropriate time, and the clock will start.

**Note:** If the TV is unplugged or you experience a power outage, you must reset the clock for any timer functions to work.

## CLOCK SET MESSAGES:

If you do not set the clock but attempt to use the On/Off Timer anyway, you will get the following message:

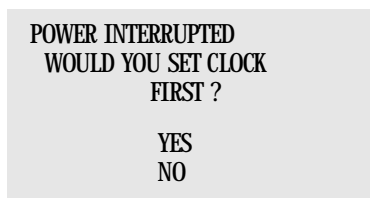

- ▼ To YES/NO
- ◀▶ Choose YES

Continued from below...



If you choose NO, you will receive the following message:



**Note:** If you attempt to "Start Clock" without setting the time you will receive this message:



## FINISH

Once you have set up the items in the Plug In Menu you must select Finish. Finish tells the TV that you have selected your personal default options for the menu and clock, and unless there is a power interruption, the Plug In Menu will not show up again.

- ▲▼ To FINISH
- ◀▶ To exit and save settings

**Note:** You can reset the options available in Plug In Menu via the regular JVC menu system:

- Language is found in the Initial Setup Menu.
- Auto Tuner Setup is found in the Initial Setup Menu.
- Tuner Mode is found in the Initial Setup Menu.
- Set Clock is found in the Clock/Timers Menu.

Continued above...





**NOTES:**

To exit the Picture Adjust menu at any time press the EXIT button.

**TINT**

Adjust the levels of red and green.

- ▲▼ To TINT
- ▶ To accentuate green
- ◀ To accentuate red
- ▲▼ To move to the next

**COLOR**

Adjust both the vividness and subtlety of the color.

- ▲▼ To COLOR
- ▶ To make colors more vivid
- ◀ To subdue colors
- ▲▼ To move to the next

**PICTURE**

Picture allows you to adjust the picture's range of black and white.

- ▲▼ To PICTURE
- ▶ To increase contrast
- ◀ To decrease contrast
- ▲▼ To move to the next

**BRIGHT**

Adjust the degree of light and dark.

- ▲▼ To BRIGHT
- ▶ To lighten the picture
- ◀ To darken the picture
- ▲▼ To move to the next

**DETAIL**

Adjust the level of detail in the picture.

- ▲▼ To DETAIL
- ▶ To make the picture sharper
- ◀ To make the picture smoother
- ▲▼ To move to the next

**NOTCH**

The Notch Filter sharpens the edges of graphics and text, especially in computer generated graphics common in news and sports programs.

- ▲▼ To NOTCH
- ◀▶ To turn ON/OFF

**NOISE MUTING**

Inserts a blue screen and eliminates noise from channels that are not broadcasting or are too weak.

- ▲▼ To NOISE MUTING
- ◀▶ To turn ON/OFF

**Note:** Noise Muting will not work when you operate the Auto Tuner Setup or Channel Summary.

**SET VIDEO STATUS**

Save Picture Settings as "Choice".

- ▲▼ To SET VIDEO STATUS
- ◀▶ To operate
- ◀▶ To operate the TINT option

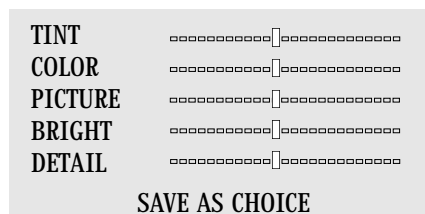

- ▲▼ To move to the next feature

Repeat the above steps to adjust each feature — color, picture, bright, detail.

- ▲▼ To SAVE AS CHOICE
- ◀▶ To save settings and exit

**Note:** Access your "Choice" settings by pressing the VIDEO STATUS button on the remote control.



# SOUND ADJUST

## NOTE:

MTS has no effect on normal sound broadcasts.

## BASS

The Bass level adjustment feature allows you to raise or lower the level of lower frequencies in the TV's sound.

- ▲▼ To BASS
- ▶ To emphasize bass
- ◀ To reduce bass
- ▲▼ To move to next

## TREBLE

The Treble level adjustment feature allows you to raise or lower the level of higher frequencies in the TV's sound.

- ▲▼ To TREBLE
- ▶ To increase treble
- ◀ To decrease treble
- ▲▼ To move to next

## BALANCE

The Balance adjustment feature allows you to center the TV's sound to your needs.

- ▲▼ To BALANCE
- ▶ To shift the speaker balance to the right
- ◀ To shift the speaker balance to the left
- ▲▼ To move to next

## MTS (Multi-Channel Television Sound)

MTS technology gives you a choice among stereo, mono, and Second Audio Programs (SAP).

- ▲▼ To MTS

MIS STEREO SAP MONO  
ON AIR↑

- ◀▶ Select the mode

(The ON AIR arrow tells you if the current signal contains Stereo or SAP)

**Note:** Keep the TV in STEREO mode to get the fullest sound quality.

**Note:** SAP will allow you to hear an alternative soundtrack, if available.

**Note:** Choose MONO to reduce excess noise in a program or channel.

## Some Sound Advice

You can tell if a program is broadcast in stereo by the position of the ON AIR arrow in the MTS menu. Unfortunately, it is common for some cable companies to squash the transmission of stereo programs to mono because they only have mono equipment. If your TV is connected to a cable system, the sound is at the mercy of that cable company — if they broadcast in mono, you receive mono sound regardless of the original stereo programming.

Fortunately, most programs that are broadcast in stereo are aired on the major television networks. If you connect your TV to an antenna instead of cable, and set the Tuner Mode (page 15) to "Air" instead of "Cable," you will be able to pick up stereo broadcasts in stereo.



## ON/OFF TIMER

YOU tell the TV to turn on and off. Use it as an alarm to wake up, as a program reminder, or as a decoy when you're out of the house.

▲▼ To ON/OFF TIMER

◀▶ To operate

ON TIME	12 : 00	AM
OFF TIME	12 : 00	AM
CHANNEL		07
MODE	ONCE	EVERYDAY
ON/OFF TIMER	YES	NO

FINISH

◀▶ To set the hour (AM/PM) you want the TV to turn on

▼ To move to minutes

◀▶ To set the minutes

▼ To accept ON TIME and to move to OFF TIME (set time again)

▼ To move to CHANNEL

◀▶ To select channel

▼ To move to MODE

◀▶ Choose ONCE or EVERYDAY

▼ To YES NO

◀▶ Choose YES for on, NO for off

▼ To FINISH

◀▶ To save settings

**Note:** In order for ON/OFF Timer to work, the clock must be set. After a power interruption it will be cancelled.

**Note:** ON/OFF Timer cannot be set to locked or guarded channels.

## SET LOCK CODE

The Lock Code locks and unlocks Channel Guard. Write this three digit number down and keep it where would-be viewers will not look for it!

▲▼ To SET LOCK CODE

◀▶ To operate

The padlock icon appears



Zero (the access code is zero)

LOCK CODE	0 0 0
	FINISH

◀▶ To choose the first number

▼ To move to the second place

◀▶ To choose the second number

▼ To move to the third place

◀▶ To choose the third number

▼ To FINISH

◀▶ To save settings and exit

**Note:** If you forget the Lock Code you can set another one this same way.

**Note:** After a power interruption you must reset the lock code.

### NOTE:

Clock/Timers function:

- Set Clock

is described in full detail on page 16.



# INITIAL SETUP

## NOTE:

Initial Setup Menu item:

- Language

is described in full detail in the Plug In Menu section on page 15.

## TV SPEAKER

You can listen to the TV speakers, or if your set is connected to a stereo, turn them off to listen to the stereo's speakers.

▲▼ To TV SPEAKER

◀▶ To turn the speaker ON or OFF

TV SPEAKER	ON	OFF
------------	----	-----



EXIT when finished

**Note:** TV Speaker will be cancelled after a power interruption.

**Note:** Before you set TV Speaker from Off to On, **make certain that the volume level is low!** If the volume is high, the sound will be extremely loud.

## AUDIO OUT

Select fixed level or variable level audio output signals.

▲▼ To AUDIO OUT

AUDIO OUT	VARI	FIX
-----------	------	-----

◀▶ To VARI or FIX

**VARI:** Adjust the volume of the external speaker by using the TV's VOLUME +/- button or it's remote control.

**FIX:** Adjust the volume of the external speaker with the audio device controls.

**Note:** When using external amplifiers and speakers, shut off the TV Speakers (above).

## CLOSED CAPTION

If they are included in a program, you can view closed captions or text information.

▲▼ To CLOSED CAPTION

◀▶ To operate and select a caption or text channel

CAPTION:	CC1	CC2	CC3	CC4
TEXT :	T1	T2	T3	T4
	FINISH			

▲▼ To FINISH

◀▶ To save settings



EXIT when finished

**Note:** Captions are usually found on CC1 and text on T1. The other caption and text channels are workable but are for future purposes.

**Note:** To activate the Closed Caption settings that you set here:



CLOSED CAPTION

(See page 22 for complete details on how to access captioning with the CLOSED CAPTION button.)

# INITIAL SETUP



## CHANNEL SUMMARY

You can add or delete channels from channel scanning. You can also lock out any "unauthorized" viewers from one or up to all 181 channels.

▲▼ To CHANNEL SUMMARY

◀▶ To operate

**Note:** Noise Muting will not work while you are in the Channel Summary menu.

## SCAN

You can manually set channels to scan that were too weak to be picked up during Auto Tuner Setup. Conversely, if a channel was too weak to receive a good picture but was picked up anyway, delete it by removing the . (If you have not performed the Auto Tuner Setup described on page 15, do so now.)

CH NO	SCAN	🔒	CH NO	SCAN	🔒
			06		
02			07		🔒
03			08		🔒
04			09		
05			10		



CHANNEL +/- to select the channel

▲▼ To the SCAN column

◀▶ To include or delete from scan



EXIT when finished

**Note:** Channels set to scan will be marked with a .

**Note:** Some cable systems experience interference from radio frequencies on Cable Channel 95. If you like, you can delete this channel from scanning by removing the .

Continued from below...

## CHANNEL GUARD - LOCK

▲▼ To CHANNEL SUMMARY

◀▶ To operate

CH NO	SCAN	🔒	CH NO	SCAN	🔒
			06		
02			07		🔒
03			08		🔒
04			09		
05			10		

▲▼ To the Lock column



The access code zero (0) to lock or unlock that channel

Use the CHANNEL +/- button to go to any other channel you want to lock



EXIT when finished

## CHANNEL GUARD MESSAGE:

This message appears when a viewer attempts to watch a guarded channel:

THIS CHANNEL IS LOCKED BY  
CHANNEL GUARD.  
PLEASE ENTER LOCK CODE BY  
10 KEY PAD TO UNLOCK IT.  
NO. \_ \_ \_

To watch a channel you have locked, enter the lock code using the 10 key pad.

If the wrong lock code is entered, this message will appear:

INVALID LOCK CODE !

## NOTES:

Initial Setup Menu items

- Auto Tuner Setup, and
- Tuner Mode are described in detail on page 15 in the Plug In Menu section.

### In the Channel Summary:

To move up and down a column (e.g. from channel to channel) use the CHANNEL +/- button.

To move from item to item (e.g. from channel number to add to lock) use the arrow up/down keys.

Continued above...



# BUTTON FUNCTIONS

## NOTES:

Please note that if the TV Clock, SleepTimer, or On/Off Timer are not set, the initial Display screen will state "Clock Not Set," "Sleep Timer Off," and "On/Off Timer Off," respectively.

## DISPLAY

The Display screen shows the current status of timers and inputs.



DISPLAY

07	
NOW	12:20 PM
SLEEP TIMER	OFF
ON/OFF TIMER	EVERYDAY
ON TIME	7:00 PM
OFF TIME	10:00 PM

- The channel or AV input (Channel 07)
- Current time (12:20 PM)
- Sleep Timer status minutes remaining (Off)
- On/Off Timer status (Everyday, on at 7:00 PM, off at 10:00 PM)
- Each press of the DISPLAY button changes the display mode:

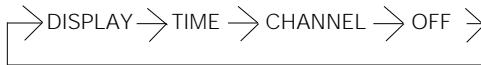

## CLOSED CAPTION

View the closed captions or text when included in a program.



CLOSED CAPTION



- Note:** To change caption or text channels see page 20.
- Note:** To access a captioning option or to turn one off, allow the display to remain on screen until it disappears. In a few seconds the captions will start.
- Note:** CC2, CC3, CC4, T2, T3, and T4 are functional, however, they are for future purposes.
- Note:** If a large black box covers 80% of your screen, the Text Mode is probably set. Press CLOSED CAPTION to turn it off.

## VIDEO STATUS

The Video Status button lets you select the "Choice" settings of the Set Video Status menu, or reset to factory settings.

"Standard" resets the picture settings to factory standard levels.

"Choice" consists of the settings that you saved in the Set Video Status menu, page 17.

"Theater" for a film-like look to video.



VIDEO STATUS



## SLEEP TIMER

Sleep Timer turns off the TV for you in case you fall asleep. Program it to work in intervals of 15 minutes up to 180 minutes.



SLEEP TIMER

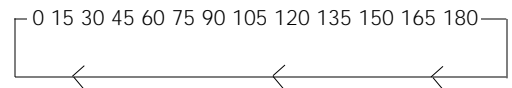

## SLEEP TIMER MESSAGE:

20 seconds prior to the automatic shut-off, this message will appear:

**GOOD NIGHT !!**  
**PUSH SLEEP TIMER BUTTON**  
**TO EXTEND.**

You then have 20 seconds to press the Sleep Timer button to delay turn off for another 15 minutes.

# BUTTON FUNCTIONS



## NOTES :

You can find another discussion of Return and Return+ on page 11.

## HYPER SURROUND

Creates a deep, 3-dimensional sound effect by channeling the sound through the TV's front firing speakers.

## TV / VIDEO

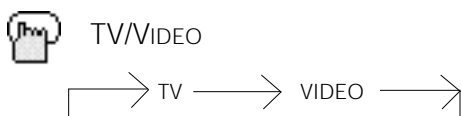

TV/Video selects the input mode.



## 100 +

The 100+ button accesses all channels above Channel 99.

To move to Channel 124:

-  100+
-  2 (two)
-  4 (four)

## VCR BUTTONS

This remote will control your VCR. It is preset to control a JVC VCR. For any other brand, you must set the manufacturer's code (page 13).

## MENU BUTTONS

The MENU buttons allow you to control the options located in the menu screens. See page 14 for a complete discussion on these buttons.

## MUTING

The MUTING button turns the sound off completely when you press it. Press it again to restore the volume to the previous level.

## RETURN+

There are two kinds of Return...

**Return+** — Set a "Return Channel" to return to after scanning with CHANNEL +/-.

-  RETURN+ and hold for 3 seconds

RETURN CHANNEL  
PROGRAMMED !

Scan with CHANNEL +/-

-  RETURN+

**Note:** To cancel a Return channel, press and hold Return+ for another 3 seconds until "Return Channel Cancelled!" appears.

**Return** — Return to the last channel viewed after moving to another channel via the 10 key pad.

-  RETURN+  
Move to another channel with the 10 key pad.



-  RETURN+

## NUMBER BUTTONS

### 10 KEY PAD

Change channels with the 10 key pad.

For example, to move to Channel 7:

-  0 (zero)
-  7 (seven)



# TROUBLESHOOTING

PROBLEMS	CHECK
No power	<ul style="list-style-type: none"> <li>• See if the power cord became unplugged.</li> <li>• Perhaps you have experienced a blown circuit breaker or fuse or a power outage.</li> </ul>
No picture or sound	<ul style="list-style-type: none"> <li>• The antenna could be disconnected.</li> <li>• The input mode (TV or Video) could not be set properly, refer to page 23.</li> <li>• The tuner mode (in the menu selection) could be set improperly, refer to page 15.</li> <li>• The station may be having difficulties, check to see if other channels are operating normally.</li> </ul>
Remote control is not operating	<ul style="list-style-type: none"> <li>• Check that the batteries are still working and properly installed.</li> <li>• Make sure there are no objects blocking a clear path from the remote to the TV.</li> <li>• Check that the TV/CATV switch is in the proper position — set to TV to view television.</li> </ul>
You cannot select a certain channel	<ul style="list-style-type: none"> <li>• Maybe you are too far from the TV, you must be within 23 feet (or 7 meters).</li> <li>• Make sure the channels are programmed. See Channel Summary, page 21.</li> <li>• Perhaps the channel is locked, select it with the 10 key pad and follow instructions.</li> </ul>
Power turns off	<ul style="list-style-type: none"> <li>• Perhaps the On/Off Timer is set, press the power button, check page 19.</li> <li>• The power was interrupted or the power cord unplugged. Reset the clock, check page 16.</li> <li>• The Sleep Timer may be set.</li> </ul>
The clock is wrong	<ul style="list-style-type: none"> <li>• The power was interrupted and the clock not reset. Reset the clock, check page 16.</li> </ul>
PICTURE	CHECK
Poor color quality	<ul style="list-style-type: none"> <li>• Tint and color may be improperly adjusted. Check page 17.</li> <li>• Video Status mode may be set to an inappropriate setting. Check page 17.</li> </ul>
Lines or streaks across the screen	<ul style="list-style-type: none"> <li>• There could be interference from another energy consuming appliance, such as a computer, another TV or VCR. Move any other such appliances farther away from the TV.</li> </ul>
Spotted picture	<ul style="list-style-type: none"> <li>• There could be interference from a running high wattage appliance such as a hair-dryer, vacuum cleaner, or neon sign. You will have to move the antenna away from the source of the interference or change it to a coaxial cable which is less prone to interference.</li> </ul>
Double picture (Ghosts)	<ul style="list-style-type: none"> <li>• A building or airplane can reflect the original signal producing a second, delayed one. Adjust the antenna position.</li> </ul>
Snowy picture/ Image noise	<ul style="list-style-type: none"> <li>• The antenna may be damaged, disconnected or turned. Check the antenna connection, pages 6 to 7. If it is damaged, you will have to replace it.</li> </ul>
Screen is 80% black	<ul style="list-style-type: none"> <li>• Closed Caption Text Mode is on. Press the CLOSED CAPTION button until you select Off.</li> </ul>
SOUND	CHECK
Bilingual or stereo programs can't be heard	<ul style="list-style-type: none"> <li>• Make sure the MTS mode is properly set. Refer to page 18 for details on setting MTS Modes.</li> </ul>
No sound from TV speakers at all	<ul style="list-style-type: none"> <li>• TV Speakers may be turned off in the menu, see page 20.</li> </ul>
NOT A PROBLEM	DON'T WORRY ABOUT THIS, IT'S NORMAL
Static electricity	<ul style="list-style-type: none"> <li>• It is normal to feel a surge of static electricity if you brush over or touch the screen.</li> </ul>
Occasional crackling sounds	<ul style="list-style-type: none"> <li>• It is normal for the TV to emit crackling sounds when turned on or off. Unless the sound or picture become abnormal, this is fine.</li> </ul>





# LIMITED WARRANTY



For Canadian model televisions, see separate sheets for Warranty/Garantie and JVC Authorized Service Centers in Canada.

JVC COMPANY OF AMERICA warrants this product and all parts thereof, except as set forth below TO THE ORIGINAL PURCHASER AT RETAIL to be FREE FROM DEFECTIVE MATERIALS AND WORKMANSHIP from the date of original purchase for the period as shown below (the "Warranty Period"). The picture tube is covered for two years.

Model No.	Serial No.	Parts	Labor
		1 YEAR	1 YEAR

This limited warranty is valid only in the fifty (50) United States, The District of Columbia and the Commonwealth of Puerto Rico.

### JVC WILL:

If this product is found to be defective, repair or replace defective parts at no charge to the original owner. Such repairs will be made during regular business hours only at JVC authorized service centers. All parts repaired or replaced are warrantied for the remainder of this Warranty Period only. All products and parts should be brought to an authorized service center on a carry-in basis except for those models with a screen size larger than 25 inches which are covered on an in-home basis.

### YOU MUST:

- Return your products to a JVC authorized service center with a copy of your bill of sale. For the authorized JVC service center nearest you, call toll free (800) 252-5722.
- If service is not locally available, box the product carefully, preferably in its original container, and ship it, insured, to the nearest authorized service center with a copy of the bill of sale and a letter of explanation as to the problem. Call the toll free number above for the address.

### WHAT IS NOT COVERED:

- 1) Products which have been subject to abuse, accident, alteration, modification, tampering, negligence, misuse, faulty installation, lack of reasonable care, or if repaired or serviced by anyone other than a service facility authorized by JVC to render such service, or if connected to any attachment not provided with the products, or if the model or serial number has been altered, tampered with, or removed;
- 2) Initial installation, removal for repair, and reinstallation after repair is not covered;
- 3) Operational adjustments covered in the Owner's manual, normal maintenance, video and audio head cleaning;
- 4) Damage that occurs during shipment, due to an act of God, or of consequence to cosmetic changes;
- 5) Signal reception problems and failures due to line power surges;
- 6) Video Pick-up Tubes/CCD Image Sensor, Cartridge, Stylus (Needle) are covered for 90 days from the date of purchase;
- 7) Accessories, and;
- 8) Batteries (except for rechargeable batteries which are covered for 90 days from date of purchase.)

There are no express warranties except as listed above.

THE DURATION OF ANY IMPLIED WARRANTIES, INCLUDING THE IMPLIED WARRANTY OF MERCHANTABILITY, IS LIMITED TO THE DURATION OF THE EXPRESS WARRANTY HEREIN.

JVC SHALL NOT BE LIABLE FOR THE LOSS OF USE OF THIS PRODUCT, INCONVENIENCE, LOSS OR ANY OTHER DAMAGES, WHETHER DIRECT, INCIDENTAL OR CONSEQUENTIAL (INCLUDING, WITHOUT LIMITATION, DAMAGE TO TAPES, RECORDS OR DISCS) RESULTING FROM THE USE OF THIS PRODUCT, OR ARISING OUT OF ANY BREACH OF THIS WARRANTY, ALL EXPRESS AND IMPLIED WARRANTIES, INCLUDING THE WARRANTY OF MERCHANTABILITY AND FITNESS FOR PARTICULAR PURPOSE, ARE LIMITED TO THE WARRANTY PERIOD SET FORTH ABOVE.

Some states do not allow the exclusion of incidental or consequential damages or limitations on how long the warranty lasts, so these may not apply to you. This warranty gives you specific legal rights and you may also have other rights which vary state to state.

If you have questions concerning your JVC product, please contact our Customer Relations Department:

**JVC COMPANY OF AMERICA**  
DIVISION OF US JVC CORP.

41 Slater Drive  
Elmwood Park, New Jersey 07407

Refurbished products carry a separate warranty. This warranty does not apply for details of refurbished product warranty. Please refer to the refurbished product warranty information packaged with each refurbished product.



# AUTHORIZED SERVICE CENTERS

For Canadian model televisions, see separate sheets for Warranty/Garantie and JVC Authorized Service Centers in Canada.

## CALL TOLL FREE (800) 252-5722

- 1) **To locate the JVC Authorized Service Center nearest you.**
- 2) **To purchase parts or accessories.**
- 3) **For customer relations or hook-up assistance.**
- 4) **To locate the JVC authorized dealer nearest you.**

## JVC SERVICE & ENGINEERING COMPANY OF AMERICA DIVISION OF U.S. JVC CORP.

### FACTORY SERVICE CENTER LOCATIONS

Dear customer;

In order to receive the most satisfaction from your purchase, read this guide before operating the unit, and before calling for service make sure you check the Troubleshooting pages at the end of this book. In the event that repair is necessary, or for the address nearest you, please refer to the factory service center list below, or within the continental United States, call the toll free number above for an authorized service center. Remember to retain your bill of sale for warranty service.

107 Little Falls Road  
Fairfield, NJ 07004-2105  
(201) 808-9279

1500 Lakes Parkway  
Lawrenceville, GA 30243-5357  
(404) 339-2522

705 Enterprise Street  
Aurora, IL 60504-8149  
(708) 851-7855

5665 Corporate Avenue  
Cypress, CA 90630-0024  
(714) 229-8011

10700 Hammerly Suite 110  
Houston, TX 77043  
(713) 935-9331

2969 Mapunapuna Place  
Honolulu, HA 96819-2040  
(808) 833-5828

230 Eliot Street  
Ashland, MA 01721-2377  
(508) 881-5923

8192 State Road 84  
Davie, FL 33324  
(954) 472-1960

890 Dubuque Avenue  
South San Francisco, CA 94080-1804  
(415) 871-2666

Sophisticated electronic products may require occasional service. Just as quality is a keyword in the engineering and production of the wide array of JVC products, service is key to maintaining the high level of performance for which JVC is world famous. The JVC service and engineering organization stands behind our products.

National Headquarters  
JVC Service & Engineering Company of America  
Division of U.S. JVC Corp.  
107 Little Falls Road  
Fairfield, NJ 07004-2105

**THERE ARE NO USER  
SERVICEABLE PARTS INSIDE  
THIS TV! TO PREVENT  
ELECTRIC SHOCK, DO NOT  
OPEN CABINET AND DO NOT  
ATTEMPT TO  
SERVICE THIS TV YOURSELF.**



### SHIPPING INSTRUCTIONS

- Pack the TV in the original carton or one of equivalent size and strength. Use the original foam cushions or equivalent padding.
- Enclose a letter of explanation stating the problem that exists and a copy of the bill of sale.
- Print your home address on both the outside and inside of the shipping carton.
- Send to address nearest you in the list above.

# SPECIFICATIONS



MODEL	AV-32920
Reception format	NTSC, BTSC System (Multi Channel Sound)
Reception range	VHF 2 to 13. UHF 14 to 69 Sub Mid, Super, Hyper and Ultra bands (181 channel frequency synthesizer system)
Power consumption	Max. 135W / 1.8A
Screen size	32 inch / 80 cm measured diagonally full square
Audio output	3W + 3W
Speakers	2" x 4 3/4" / 5 x 12 cm oval type x 2
Antenna terminal	75 ohms (VHF/UHF) (F-Type Connector)
External input jacks	Video: 1 Vp-p, 75 ohms Audio: 500mVrms (-4dBs) high impedance
S-Video input jack	Y: 1 Vp-p positive, 75 ohms (negative sync provided) C: 0.286 Vp-p (burst signal), 75 ohms
Variable audio output jacks	More than 0 to 1550mVrms (+6dBs) Low impedance (400 Hz when modulated 100%)
AV Compu Link jacks	3.5 mm ø mini jack x 1
Dimensions (inches) WxHxD (cm)	30 1/4 x 26 1/4 x 21 1/2 76.8 x 66.7 x 54.7
Weight (lbs. / kg.)	112.5 / 51.0
Accessories	Remote control unit x 1 / AA batteries x 2

*Specifications subject to change without notice.*



**JVC COMPANY OF AMERICA**  
A Division of U.S. JVC CORP.  
41 Slater Drive  
Elmwood Park, New Jersey 07407

**JVC CANADA, INC.**  
21 Finchdene Square  
Scarborough, Ontario  
Canada M1X 1A7



LCT0157-001A-A  
0198-TN-JII-JIM